



INSTALLATION GUIDE

!WARNING! IMPORTANT NOTICE

100% Silicone must be used in conjunction with the provided double faced tape or the signs WILL FALL OFF the wall. Please do not hesitate to contact Bennu if you have any questions about installation.



TABLE OF CONTENTS

MOUNTING LOCATION for ROOM SIGNS 3

- 1. Tactile Character Sizes 3
- 2. Sign Sizes 3
- 3. Single Out-swinging Door 4
- 4. Single In-swinging Door 4

SPECIAL MOUNTING SITUATIONS for ROOM SIGNS 5

- 1. Double Doors (*both active*) 5
- 2. Double Doors (*with inactive leaf*) 5
- 3. Glass Side Light Adjacent to Latch Side of Door 6
- 4. Presence of Building Elements 6
- 5. Presence of Molding or Change in Wall Surface 6
- 6. Door Located Close to Corner Wall 7
- 7. Case by Case Situations 7

OVERHANGING SIGNS 8

PROJECTING SIGNS 8

MOUNTING TEMPLATE for ROOM SIGNS 9



The revised USA 2010 guidelines allow for a range of mounting heights that can be determined by the sign design as well as the usage by the facility. All interior wall-mounted room signs are to be installed so that the tactile characters are located as follows:

1. Tactile characters shall be 48 inches (1220 mm) minimum and 60 inches (1525 mm) maximum above the adjacent floor, measured from the baseline of the characters. If the text is multi-lined, measure from the baseline of the first (top) line of tactile text and the baseline of the last (bottom) line of tactile text.
2. Signs shall have a minimum 18 inches x 18 inches (455 mm x 455 mm) space on the floor, centered on the sign, beyond the arc of any door swing between the closed position and 45° open position. This regulation applies to out-swinging doors (doors that open towards you).

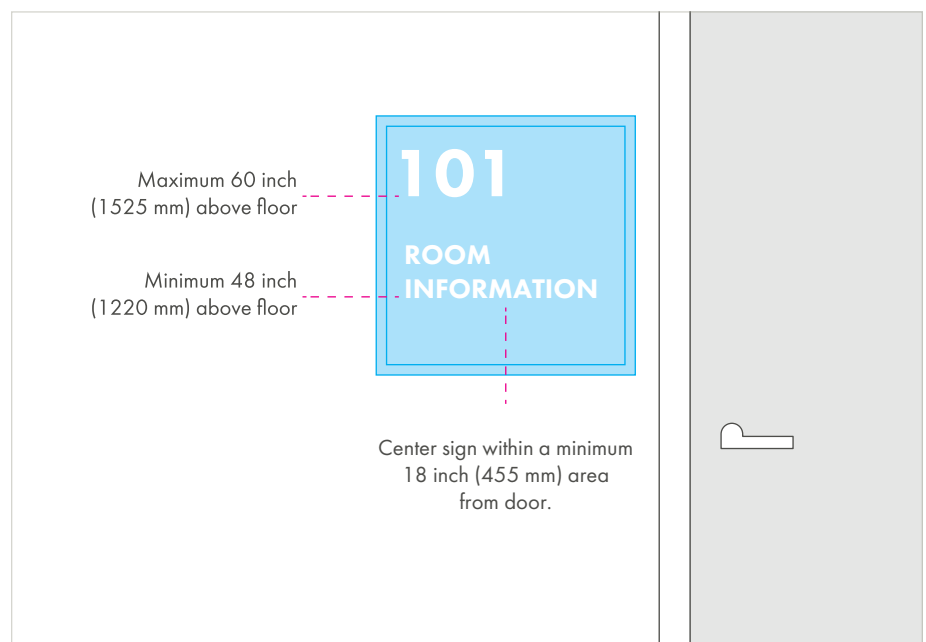



3. SINGLE OUT-SWINGING DOOR

(door opens towards individual)

Mount sign on latch side of door. Tactile text must be located within 48-60 inches (1220-1525 mm) above the floor, measured from the baseline of the first and last line of tactile text. Position the sign a minimum of 9 inches (227.5 mm) from the edge of the door to the center of the sign.

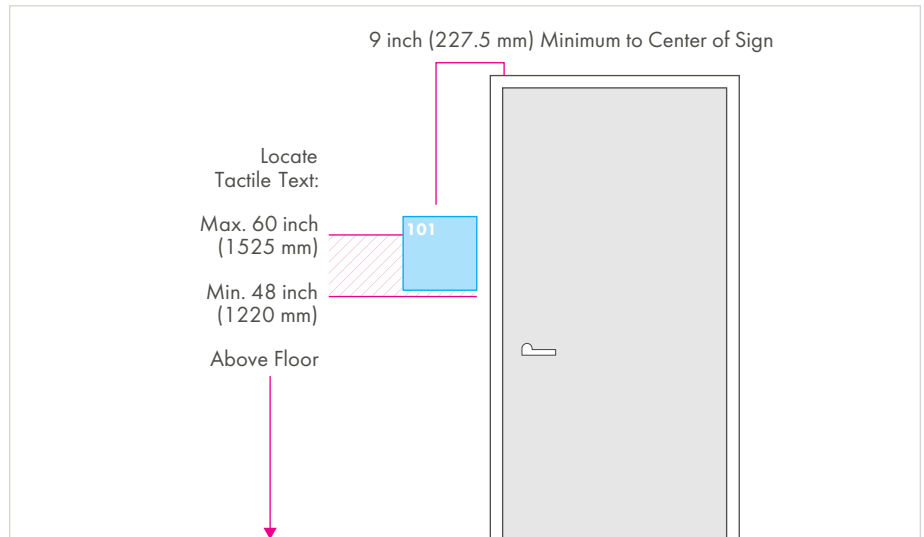

4. SINGLE IN-SWINGING DOOR

(door opens away from individual)

The new standards allow for mounting signs on the push side of doors that contain automatic closers and without hold-open devices.

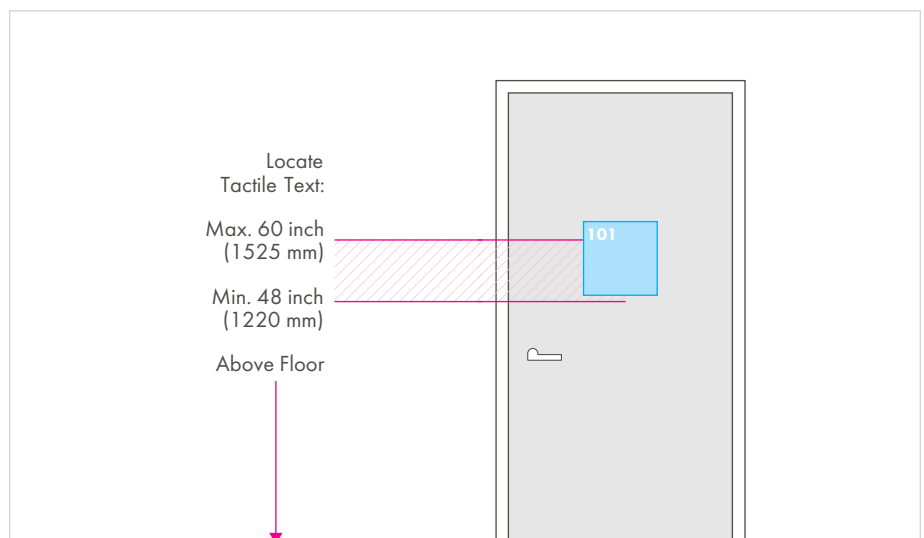



1. DOUBLE DOORS (BOTH ACTIVE)

In a situation where there are rooms with out-swinging double doors and it is not possible to mount the sign adjacent to the latch side of the door, mount the room sign adjacent to the right door. Remember: The sign must be located “out of the path of the door swing” so that a reader can approach the sign and not be hit by an opening door.

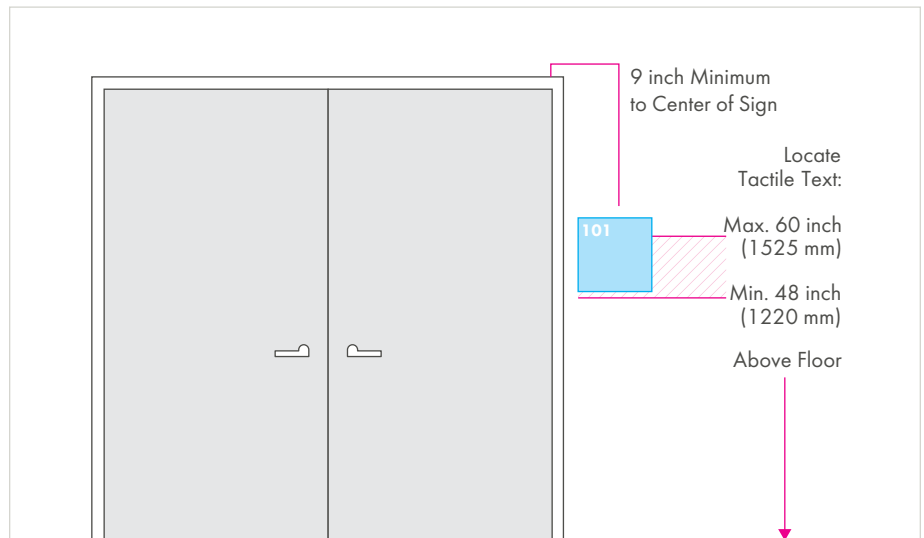

2. DOUBLE DOORS (WITH INACTIVE LEAF)

For out-swinging double doors where one door is normally locked in place, mount the room sign on the inactive leaf a minimum of 9 inches (229 mm) from the center of the sign to the meeting edge of the door.

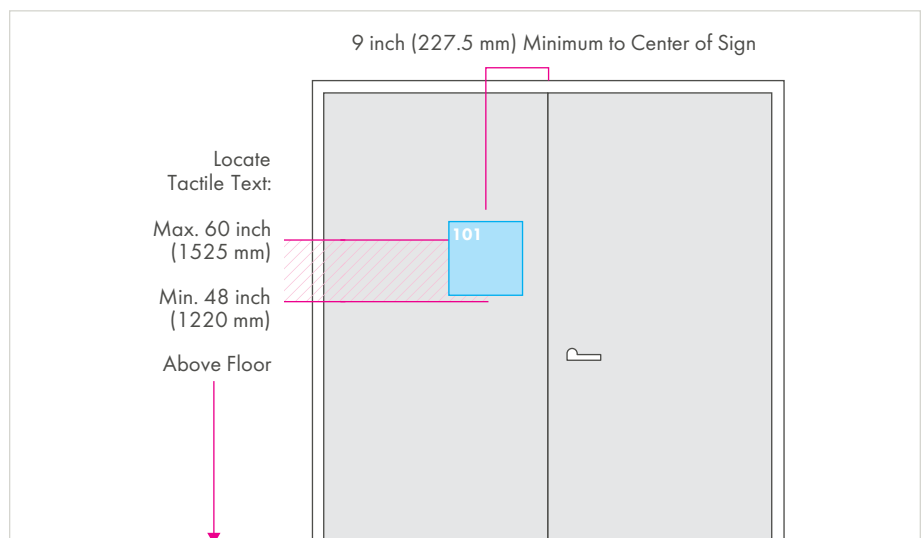



3. GLASS SIDE LIGHT ADJACENT TO LATCH SIDE OF DOOR.

Mount the room sign to the glass face of the side light with adhesive foam tape.

NOTE: When mounting any framed signs to glass we suggest you add a Backplate made of a piece of 1 /16 inch (1.6 mm) engraving stock, cut to the size of the frame , and mount with pressure-sensitive tape to the opposite glass face. This helps to conceal the back of the frame and provides a clean finished look.

For narrow glass side lights that are less than 12 inches (305 mm), the sign can be mounted on the wall next to the sidelight on the latch side of the door.

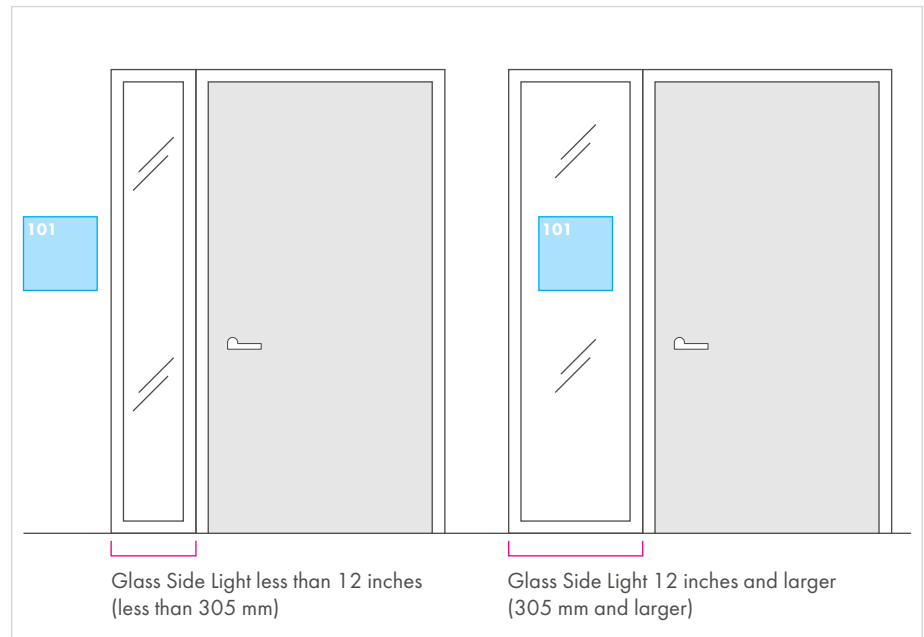

4. PRESENCE OF A BUILDING ELEMENT SUCH AS A FIRE EXTINGUISHER, THERMOSTAT, UTILITY BOX, ETC., WITHIN THE SIGN LOCATION AREA.

If the building element cannot be moved, the sign should be mounted approximately 3 inches (76 mm) from the building element, adjacent to the latch side of the door.

5. PRESENCE OF MOLDING OR CHANGE IN WALL SURFACE MATERIAL WITHIN THE SIGN LOCATION AREA.

Some building conditions may require that the molding be cut away from the sign location area and the surface materials be made flush with each other to accommodate the sign frame.that contain automatic closers and without hold-open devices.



6. DOOR LOCATED CLOSE TO CORNER WALL.

In a situation where there is not enough wall space on the latch side of the door to mount a room sign, you may mount the sign on the nearest adjacent wall (as shown below). Special care should be taken to keep the sign away from the door swing.

The revised standards (ANSI / ADAAG) call for a minimum 18 inches x 18 inches (455 mm x 455 mm) space on the floor (centered on the sign) beyond the arc of any door swing between the closed position and 45° open position.

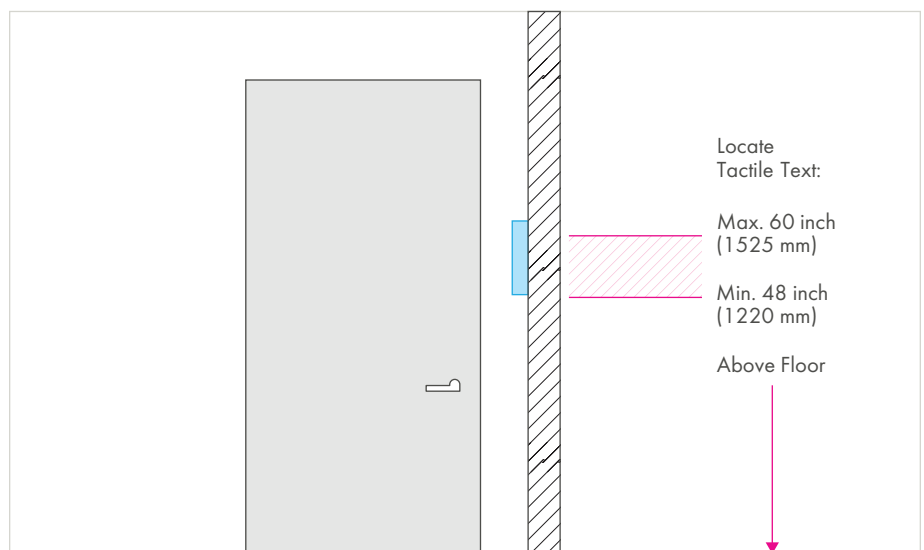
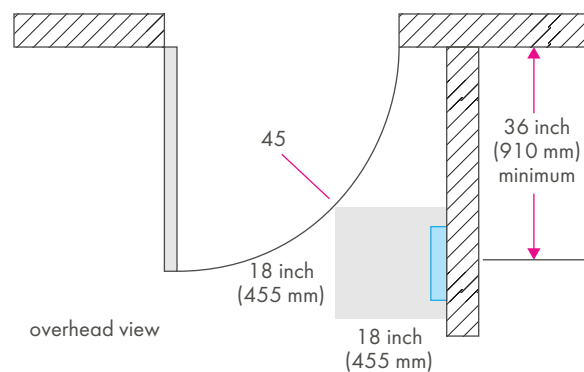

7. If the preceding options are not available you will have to make a determination, on a case by case basis, as to the best mounting location. You can consider the following location options only if no other option exists:

OUT-SWINGING DOOR (door opens towards individual):

Locate sign on the wall at the hinge side of the door, out of the path of the door swing.



OVERHANGING SIGNS

Overhanging signs projecting more than 4 inches (102 mm) must leave 80 inches (2032 mm) of headroom between the bottom of the sign and the floor.

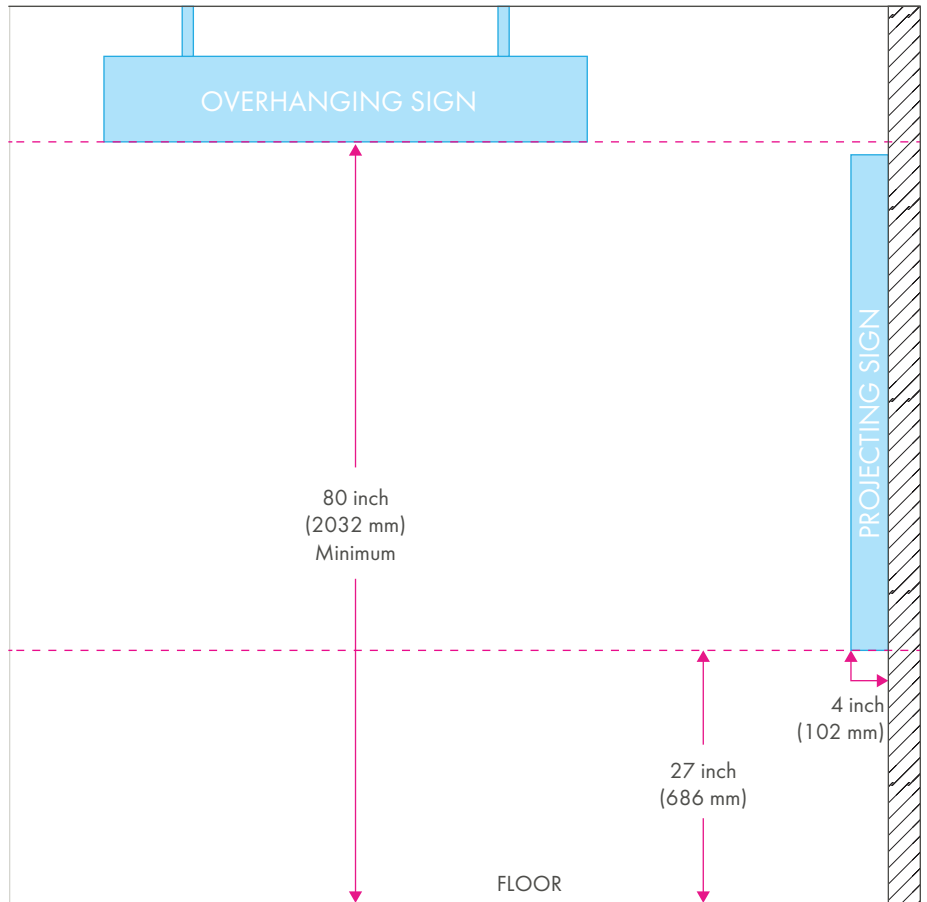

PROJECTING SIGNS

Projecting signs more than 4 inches (102 mm) must leave 80 inches (2032 mm) of headroom between the bottom of the sign and the floor.

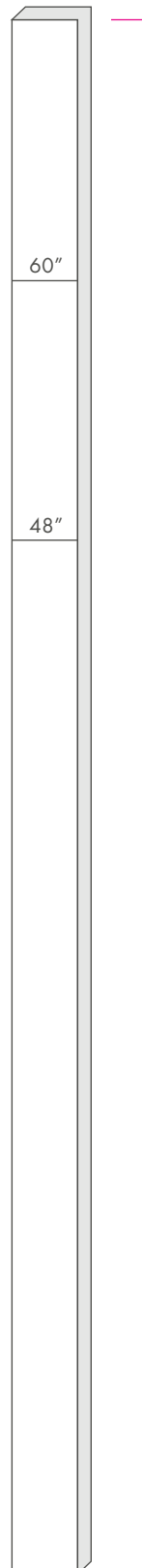

A mounting template makes installation fast and easy. Shown here is a simple piece of wood molding that is approximately 72 inches x 3 inches (1829 mm x 76 mm).

Mark "top of sign" locations directly on the mounting template for commonly used sign sizes. To use this template, position it against the door frame with the bottom edge resting on the floor. Then using the actual sign or sign frame, either directly install the sign (if using tape) or mark your drill holes. Use a level to make sure the sign is straight.

This size template works great for signs 8 inches (203 mm) in width or larger. For smaller signs, you can add spacers to the template so that the signs are installed the proper distance away from the door or simply position the template the appropriate distance away from the door.

!WARNING! IMPORTANT NOTICE

100% Silicone must be used in conjunction with the provided double faced tape or the signs **WILL FALL OFF** the wall. Please do not hesitate to contact Benu if you have any questions about installation.